

Date:	Project:	Type:	Notes:	Catalog #:
-------	----------	-------	--------	------------

## LECB-AOK SERIES Adjustable Output LED High Bay



The LECB Series is the perfect lighting solution for a wide variety of applications. LED technology allows power and light levels to be customized to meet both energy and design needs.



### Features & Specifications

#### Applications

Ideal for use in warehouses, distribution centers, retail, gymnasiums, commercial and industrial applications.

#### Construction

Housing made 24 gauge cold rolled steel and is finished with a post-production baked white powder coat. Frosted lens.

#### Mounting

V- Hooks included for suspension mount. Chain and cable mount ready. Surface mount available. Cord and plug options offered.

#### Electrical

Utilizes high-efficiency LED power supply and circuit boards. 120-277V & 0-10V dimming standard. 480V option. 50/60HZ input frequency.

#### Operating Temperature

Suitable for -40°C – 50°C Ambient

#### Lumen Maintenance

L70 rating of 122,000 hours

#### Warranty

Five-year warranty. Terms and Conditions Apply. See warranty documentation for more information.

#### Certification

UL Damp Listed. Adheres to LM79, LM80 and TM21 industry standards. DesignLights Consortium® (DLC) 5.1 Premium rating<sup>1</sup>. RoHS Compliant.

### Performance Data

Form Factor	Rated Wattage	Tested Wattage	Delivered Lumens	Efficacy	CRI
1x2	105W	105W	14,175 LM	135 LPW	>82
1x2	130W	130W	17,550 LM	135 LPW	>82
1x2	155W	155W	20,925 LM	135 LPW	>82
1.5x2	155W	155W	20,925 LM	135 LPW	>82
1.5x2	170W	170W	22,950 LM	135 LPW	>82
1.5x2	210W	210W	28,350 LM	135 LPW	>82
1x4	210W	210W	28,350 LM	135 LPW	>82
1x4	255W	255W	34,425 LM	135 LPW	>82
1x4	300W	300W	40,500 LM	135 LPW	>82



<b>LECB</b>								
1	2	3	4	5	5	6	6	6

**1 - Series**

**2 - Dimensions/ Wattage**

**3 - Type**

**LECB**

- 22 - 155W** (1x2 Foot, 105 Watt)  
(1x2 Foot, 130 Watt)  
(1x2 Foot, 155 Watt)
- 22 - 210W** (1.5x2 Foot, 155 Watt)  
(1.5x2 Foot, 170 Watt)  
(1.5x2 Foot, 210 Watt)
- 24 - 300W** (1x4 Foot, 210 Watt)  
(1x4 Foot, 255 Watt)  
(1x4 Foot, 300 Watt)

**AOK** (Adjustable Output and Kelvin Temp 40K & 50K)

**4 - Controls**

- OS** (Occupancy Sensor)
- [PRGOS-LS](#) (Sensorswitch LSXR-ADC-3v Occ Sensor w/ Dimming Photocell)
- [PRGOS-LR](#) (IRTEC LRD509 Programmable Occ Sensor w/ Remote Control)

**5 - Options**

- EM5W** (Battery Backup, 5 Watts, ~650 lumens)<sup>2</sup>
- EM10W** (Battery Backup, 10 Watts, ~1300 lumens)<sup>2</sup>
- EM5WT20** (Title 20 Compliant Battery Backup, 5 Watts, ~650 lumens)<sup>2</sup>
- EM10WT20** (Title 20 Compliant Battery Backup, 10 Watts, ~1300 lumens)<sup>2</sup>
- ETS-DR** (Emergency Control Device with 0-10V Relay)
- 480SD** (480 Step-Down)
- PLG** (6' SJT Cord & Plug)
- C6** (6' Cord)
- L7/15P** (277VT Twist-lock Plug)
- PP** (PowerPlus)
- BAA** (Buy American Act Compliant)

**6 - Accessories (Sold Separately)**

- 10GL** (10' Loop w/ Gripple Hanging Kit)<sup>3</sup>
- TMB** (Top Mount Box)
- SMK-1** (Surface Mount Kit 105WT, 130WT, 155WT & 255WT & 300WT)
- SMK-2** (Surface Mount Kit 170WT & 210WT)
- CB-12-WG-V5** (13" x 24" Wireguard 105WT, 130WT, & 155WT)
- CB-22-WG-V5** (17" x 24" Wireguard 155WT, 170WT & 210WT)
- CB-14-WG-V5** (13" x 48" Wireguard 210WT, 255WT & 300WT)

**Notes**

- 1 Not all versions of this product may be DLC Premium qualified or DLC qualified. Please check the DLC Qualified Products List at [www.designlights.org/](http://www.designlights.org/) to confirm which versions are qualified.
- 2 Lumens will change based on fixture selection. Consult with factory for additional options.
- 3 Mounting kit is manufactured by Gripple Inc.

## Photometric Data

LECB-22-130WT-40K Tested in accordance to IESNA LM-79

### Zonal Lumen Summary

Zone	Lumens	%Luminaire
0-10	624.31	3.66%
10-20	1,791.19	10.49%
20-30	2,707.05	15.86%
30-40	3,222.12	18.88%
40-50	3,193.20	18.71%
50-60	2,634.74	15.44%
60-70	1,781.07	10.45%
70-80	900.14	5.27%
80-90	214.87	1.26%

### Polar Graph

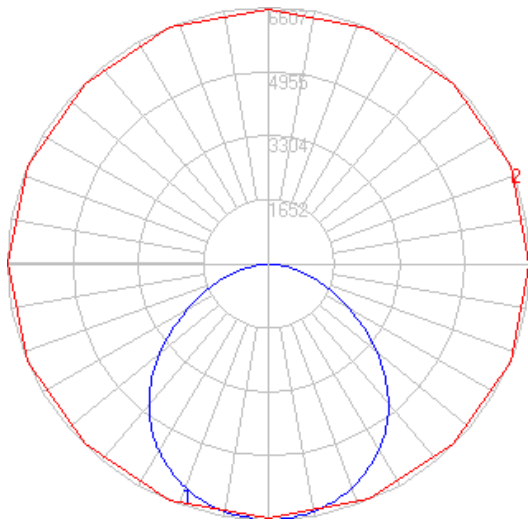

### End View

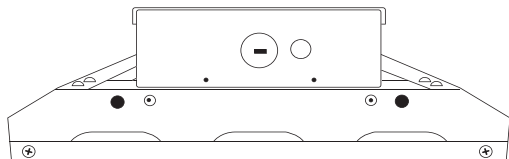

## Physical Characteristics

### Dimensions

Version	Depth	Length	Width	Weight
105W, 130W, 155W	3.62"	23.8"	13.0"	10lbs
155W, 170W & 210W	3.62"	23.8"	17.3"	14lbs
210W, 255W & 300W	3.62"	45.9"	13.0"	18lbs

### Front View

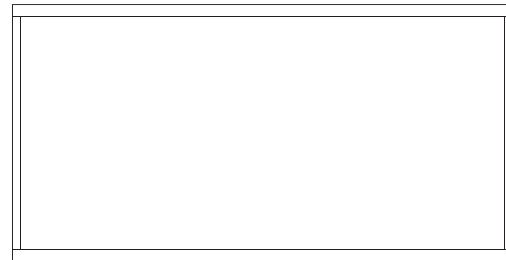

### Back View

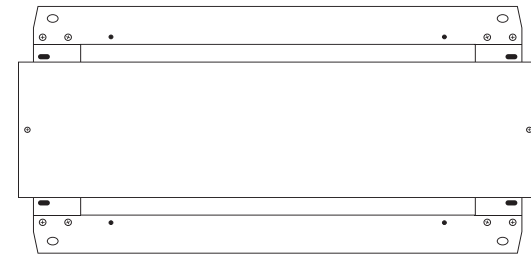

### Side View



## Versions

LECB-24 (1x4 housing)



## Mounting

SMK-1 (Surface Mount Kit 105W/ 130WT/ 155WT, & 255W/ 300W)

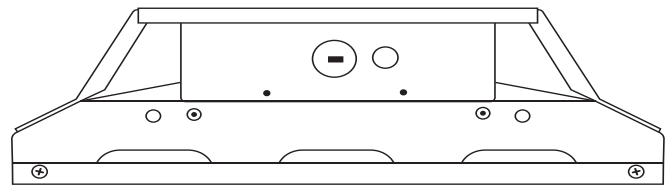

*SMK-1 Installed*

SMK-2 (Surface Mount Kit 170W/ 210W)

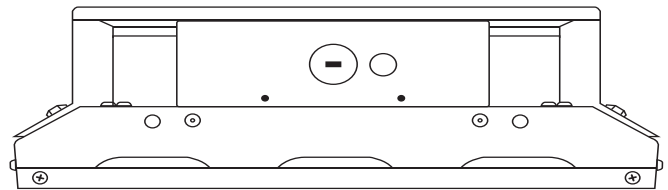
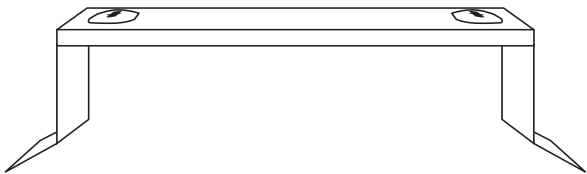

*SMK-2 Installed*

TMB (Top Mount Box)

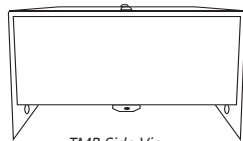
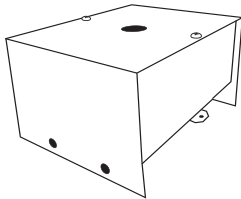

*TMB Side View*

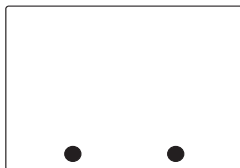

*TMB End View*

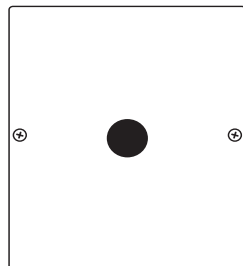

*TMB Top View*

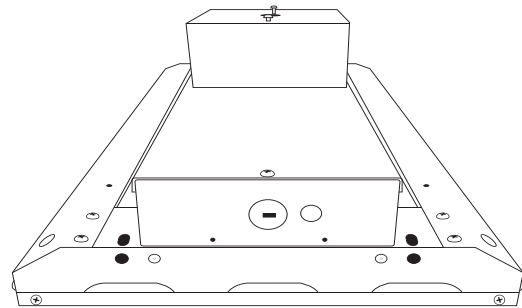

*TMB Installed*